

***T-Scale***

Technical Manual



**M301/M307**

**Body scale**

# CONTENTS

1. PRECAUTIONS.....	2
2. INTRODUCTION.....	3
3. SPECIFICATIONS.....	4
3.1 Specifications.....	4
3.2 Load Cell Specification.....	5
4. INSTALLATION.....	6
5. DESCRIPTION.....	8
6. OPERATION.....	10
1. Power ON/OFF.....	10
2. Zero.....	10
3. Tare.....	10
4. Change unit.....	10
5. Hold function.....	11
6. Print and function.....	11
7. BMI function.....	11
8. Precision*10.....	11
7. PARAMETER.....	12
8. CALIBRATION.....	14
9. PRINT FORMAT.....	16
10. BATTERY OPERATION.....	17
11. MAINTENANCE.....	18
10.1 General.....	18
10.2 Error codes.....	19
10.3 Determine the Problem.....	19
10.4 Check the Load Cell.....	20
10.5 Check PCB Voltages.....	20
10.6 Trouble Shooting.....	21
12. DISPOSAL.....	23
13. WARRANTY.....	24

# 1. PRECAUTIONS

	 <b>WARNING</b>
	<b>DISCONNECT ALL POWER TO THIS UNIT BEFORE INSTALLING, CLEANING, OR SERVICING. FAILURE TO DO SO COULD RESULT IN BODILY HARM OR DAMAGE THE UNIT.</b>

 <b>CAUTION</b>
<ul style="list-style-type: none"><li>• <b>Permit only qualified persons to service the instrument</b></li><li>• <b>Before connecting or disconnecting any components, remove the power.</b></li><li>• <b>Failure to observe these precautions bodily harm or damage to or destruction of the equipment.</b></li></ul>

- Follow the instructions in the instructions for use.
- Keep the operating instructions and the declaration of conformity in a safe place.
- Ensure that the scale is standing firmly on a smooth, level surface.
- Do not drop the scale or subject it to violent shocks.
- When using the scale with a mains unit, ensure that the supply cable is routed in such a way as to exclude any type of tripping hazard.
- Use only the type of battery stated.
- Have scale serviced and re-calibrated on a regular basis.
- Have repairs carried out only by authorized persons.

## 2. INTRODUCTION

- The M301/M307 series body scale, that amplifies signals from a load cell, converts it to digital data and displays it as a mass value.
- BMI with bar graph.
- Wheels at bottom, easy to move.
- Rubber mat on the surface of the platform.
- 25 mm LCD with white LED back light display
- 7 keypads are light touch switches
- Battery provide up to 22 hours of continues use (without backlight)
- Capacity up to 250kg / 550lb
- Height measurement: 90cm---200cm or 35inch---80 inch.(M301)

## 3. SPECIFICATION

### 3.1 Specifications

Model	M301/M307
Maximum Capacity	250kg
Readability	100g
Resolution	1/2,500
Tare range	-249.9kg
Minimum Capacity	200g
Linearity $\pm$	20g

Common Specifications	
Interface	RS-232 Output Optional
Stabilisation Time	2 Seconds typical
Operating Temperature	0°C - 40°C / 32°F - 104°F
Power supply (external)	12V/500mA AC power adapter or 2000mAh Ni-MH batteries (optional, size AA)
Calibration	Automatic External
Calibration as per Directive 90/384/EEC	Class III medical approval
Medical product as per Directive 93/42/EEC	Class I
ADC	$\Sigma$ - $\Delta$
Display	25 mm high 6 digits LCD with auto backlight and loading bar graph
Housing	Aluminium pan and pole, ABS plastic indicator
Pan Size	355x360mm
Height measuring range	From approx. 90cm to 200 cm (2'11" to 6'8")

## 3.2 Load Cell Specifications

<b>Model No</b>	<b>L6E</b>
Rated Capacity (kg)	2.5/3/5/6/8/10/15/20/30/35/40/50
Sensitivity	$2.0 \pm 0.2$ mv/v
Excitation Voltage	5~12V
Material	Aluminum
Cable	0.3~3m $\Phi$ 4mm
Input Resistance	$409\Omega \pm 6\Omega / 1065\Omega \pm 15\Omega$
Out put Resistance	$350\Omega \pm 3\Omega / 1000\Omega \pm 10\Omega$
Temperature Range	-35°C ~ +65°C
Safe overload	150%F.S
Ultimate overload	300%F.S
Error	$\pm 0.0233\%$ F.S
Creep (20min)	$\pm 0.020\%$ F.S
Zero Balance	$0 \pm 5\%$ mV/V
Max. Platform Size	250x350mm

## 4. INSTALLATION

### Unpacking

Carefully take the balance out of its package, make it sure its not damaged and all accessories are included.

- Remove the weighing scale from the carton.
- Remove the protective covering. Store the packaging and to use if you need to transport the scale later.
- Inspect the scale and terminal for damage.
- Make sure all components are included

Accessories,

1. Balance
2. Adaptor
3. Product manual

### Level Adjusting

Place the scale on a table.

Check the water mark. If, bubble is not centre adjust the leveling feet until reach centre. Check the level when you change the location.

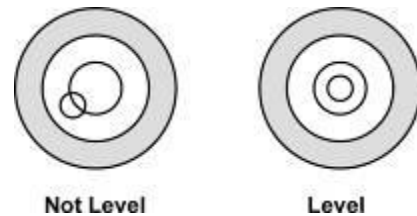

### Charging Battery

- To charge the battery insert the adaptor pin to jack, jack is locating rear side of the scale. Adaptor simply plug into the mains power. The scale no needs to be turned on.
- The battery should be charged for 12 hours for full capacity.
- In the display there is an indicator show the status of battery charging. When the scale is plugged into the mains power the internal battery will be recharged. If the indicator off, the battery has a full charge. If it is on, the battery is nearly discharged and if yellow, the battery is being charged.
- Do not use any other type of power adaptor than the one supplied with the scale.
- Verify that the AC power socket outlet is properly protected.

**Note: Please charge the battery before using the scale for the first time**

## Installation

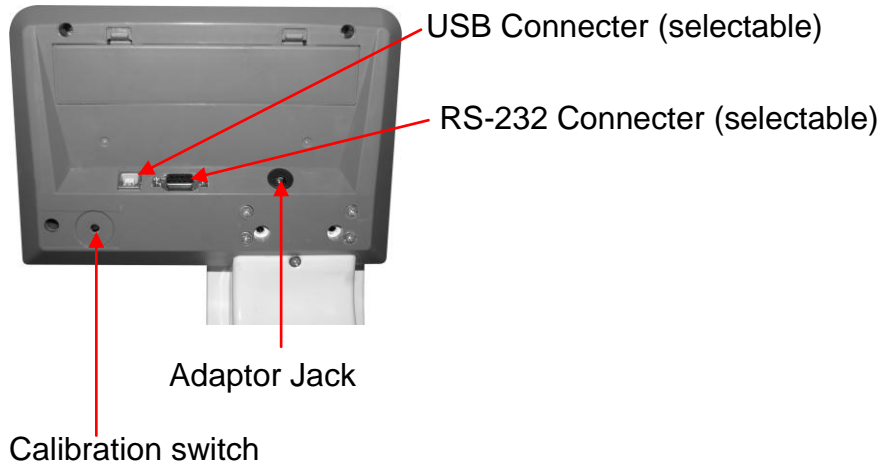

- Place the scale on a table.
- Connect the adaptor pin in to the scale adaptor jack. Adaptor jack is locating, rear side of the scale.
- Adaptor connects into your AC power socket. Pluggable equipment must be installed near an easily accessible socket outlet with a protective ground/ earth contact.
- Display will show the version number and will start self checking.
- After self checking, display will be come to normal weighing mode.
- **Warm-up time of 15 minutes stabilizes the measured values after switching on.**
- Calibrate with exact calibration weights, minimum 1/3 of the scale capacity want to use for calibration. For calibration see details in parameter.









Then you can start your operation



## 5. DESCRIPTION

### Key Board



		Turns the scale power On / Off
		Set to hold mode
		Set to BMI mode
		Set pre-tare
		Change unit: kg / lb
		Sets display to Zero
		Subtracts weight of container

## Display

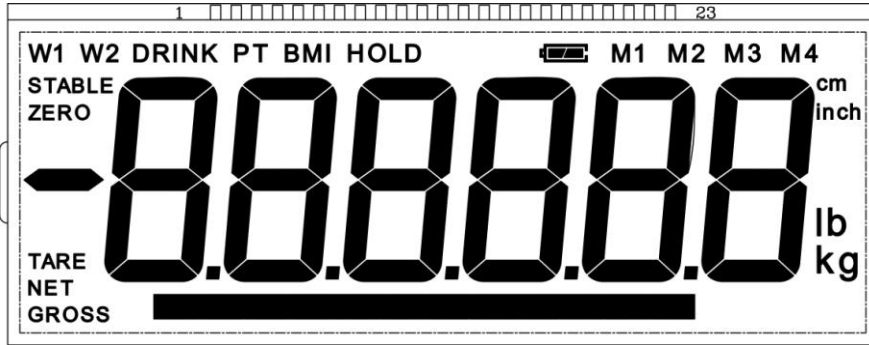

DISPLAY	FUNCTION
<b>STABLE</b>	Indicator for Display stability
<b>ZERO</b>	Indicator for Zero display
<b>TARE</b>	Indicator for Tare display
	Indicator for weighing capacity graph
<b>NET</b>	Indicator for Net weight
<b>GROSS</b>	Indicator for Gross weight
<b>Cm/inch</b>	Indicator for measuring units
<b>Lb/kg</b>	Indicator for weight units
	Indicator for Charging status of battery Voltage has dropped
	Low Voltage
	Fully Charged

## 6. OPERATION

### Initial Start-up

Warm-up time of 15 minutes stabilizes the measured values after switching on.

### 6.1 Power ON/OFF



Switch on the scale by pressing . The display is switched on and the self test is started.  
If you want to switch off press the key again.

### 6.2 Zero

Environmental conditions can lead to the balance exactly zero in spite of the pan not taking any strain. However, you can set the display of your balance to zero any time by pressing  key and therefore ensure that the weighing starts at zero.

### 6.3 Tare

You can tare the weight of any container by pressing  key so that with subsequent weighing the net weight of the object being weighed is always displayed.

- Load weight on the pan.
- Press  key. Zero is displayed, and tare is subtracted.
- Remove weight from the platform. Tared weight is displayed. It can set only one tare value. It can display with a minus value.
- Press  key. Zero is displayed, tare weight is cleared.

### 6.4 Change unit

In weighing condition, you can press  to change the unit: kg / lb.

If you want to change the unit of height measurement, please set it in parameter **F5 stu.** (page 13)

## 6.5 Hold function

Press  before load at the pan, so HOLD is active now. "Hold " and "--- --" appeared at the display.

After put load at the pan no indication until a stable non-zero weights is detected. During this period "----" is indicated. (no indication of unstable value). You will hear an acoustic beep, when stable weight (>20d) is detected.

It will show calculated HOLD-value with small "HOLD" in display.

After unloading the pan the value is indicated for 10 Seconds. After that normal weight displaying is resumed.





Pressing , while the HOLD-function is active, will cancel the HOLD-function.

In hold function, you can't do ZERO and TARE operation.

## 6.6 Print function

Press  key to print the weight value, you can disable this function (see the parameter on Section 7)

## 6.7 BMI function

Press  key on the weighing mode, display will show the last height "xxxxxx", use  key to change digit, and press  key to increase the value, press  key confirm it, display will enter into the BMI mode, "BMI" indicator will be shown, people stand on the platform display will show the BMI value and the BMI bar, Press  key will turn back to weighing mode.

## 6.8 Precision\*10

If you want to see more accurate weight value, press and hold  for 2 seconds, display will show one more decimal place, the last digit will twink for 5 seconds, then it will go back to normal weighing value automatically.

# 7. PARAMETERS

## Enter the Menu

- Press  during self checking(9--0), display will show

**F1 off**

## Choose the Menu

- Press , it can choose menu block or options one by one.

## Enter the Selected Menu

- Press , it can confirm which will be shown displayed.

## Enter in to TECH

**Note: Before enter the tech menu, press calibration switch, which is locating below the scale**

- When display showed **P i n**, press   and  keys to enter the function

## Escape from the Menu

- Press  key, it can escape from the menu to weighing mode.















## Parameter Block

Menu	Sub Menu	Description
<b>F1 off</b>	0/3/5/15/30	To set the auto power-off time. Unit is minutes. If you select 0,it will not auto power-off.
<b>F 2 swt</b>	<b>off</b>	Disable print function.
	<b>prt</b>	Enable print function.

<b>F3 prt</b>	<b>Seire</b>	Also send data continuous
	<b>P prt</b>	By pressing Print key , weighing value will be added to the memory and print the print out
	<b>P cont</b>	Send data continuous
	<b>P auto</b>	Automatic accumulation. Individual weighing values are automatically added
	<b>ask</b>	ASK mode Command R: read data Command T: Tare Command Z: Zero
	<b>P cnt2</b>	Send data another continuous mode.
	<b>P stab</b>	Send data when the weighing values is stable
<b>F4 bk</b>	<b>Bl on</b>	Set the backlight always on.
	<b>Bl off</b>	Set the backlight always off.
	<b>Bl au</b>	Set the backlight automatically on.
<b>F5 stu</b>	<b>cm</b>	Select unit cm
	<b>inch</b>	Select unit inch
<b>F6 unit</b>	<b>Kg on/off</b>	Enable/ disable unit kg
	<b>Lb on/off</b>	Enable/ disable unit lb
<b>tch</b>	<b>pin</b>	Enter the password
<b>P 1 spd</b>	Set A/D convert speed(7.5/15/30/60)	
<b>P 2 Cal</b>	<b>desc</b>	To set decimal points. Options: 0,0.0, 0.00, 0.000, 0.0000
	<b>inc</b>	To set increment Options: 1, 2, 5, 10, 20, 50 (kg) Options: 2, 5, 10, 20, 50, 100 (lb)
	<b>cap</b>	Set capacity
	<b>cal</b>	Enter into calibration
<b>P 3 pro</b>	<b>tri</b>	Deprecated function
	<b>count</b>	To show the scale internal count
	<b>reset</b>	Reset the scale
	<b>setgra</b>	Set the gravity value

## 8. CALIBRATION

### Calibration Settings in the Parameter;







- Turn on the scale
  - Press  key during self checking, display will show F1 off
  - Press  key until to display tch
  - Press  key to confirm display will show pin
  - Press   and  keys, display will show P1 spd
  - Press  key to show display P2 cal
  - Press  key to enter calibration,
  - Display will show desc
  - Press  key until display show Cal
  - Press  key into calibration, display will show unLoad
  - When scale get stable, Press  key,
  - Display will be show last calibration weight, 00100.0
- If it's required, change calibration weight value by using  and  keys
- Press  key to confirm the value
  - Display will be show Load
  - Place the test weight on the platform.
  - After stable, press  key confirm
  - Display will be show pass
  - Then will start self-test, unload test weight during the self test.
  - Scale will come to normal display

**Note:** the unit (kg / lb) is the same as the last displayed one.

That is: before you restart the scale to do calibration, if you see the unit is kg, then in calibration, the unit is kg; if you want to change to lb, you need to press U key to change the unit before you restart it.

Note: During the calibration end, when display shows **pass** and start self test, test weights should be want to unload before showing normal display for to avoid Err 19.

### Normal Calibration

- Turn on the scale
  - During the self-test, press  key **unLoad**
  - Keep empty platform
  - When scale get stable, Press  key,
  - Display will be show last calibration weight, **00100.0**
- If it's required, change calibration weight value by using  and  keys
- Press  key to confirm the value
  - Display will be show **Load**
  - Place the test weight on the platform.
  - After stable, press  key confirm
  - Display will be show **pass**
  - Then will start self-test, unload test weight during the self test.
  - Scale will come to normal display



## 9. PRINT FORMAT

PRT	Print format
0	2012/08/09 11: 00 60.0 kg
1	2012/08/09 11: 00 60.0 kg 170.0cm 20.7BMI
2	60.0 kg
3	60.0 kg 170.0cm 20.7BMI

**Note:** TPUP can't print out the date and time.

## 10. BATTERY OPERATION

The Medical Scales can be operated from the battery if desired. The battery life is 16 hours (backlight) and 22 hours (without backlight).

When the battery needs charging a symbol on the weight display will turn on. The battery should be charged when the symbol is on. The scale will still operate for about several minutes after which it will automatically switch off to protect the battery.

To charge the battery simply plug into the mains power. The scale does not need to be turned on.



The battery should be charged for 12 hours for full capacity.

Just under the quantity display is an LED to indicate the status of battery charging. When the scale is plugged into the mains power the internal battery will be charged. If the LED is green the battery has a full charge. If it is Red the battery is nearly discharged and yellow indicates the battery is being charged.

As the battery is used it may fail to hold a full charge. If the battery life becomes unacceptable then contact your distributor.

Note: useless battery should be recycled, not throw away as household refuse.

## 11. MAINTENANCE

	 <b>WARNING</b>
	<b>DISCONNECT ALL POWER TO THIS UNIT BEFORE INSTALLING, CLEANING, OR SERVICING. FAILURE TO DO SO COULD RESULT IN BODILY HARM OR DAMAGE THE UNIT.</b>

 <b>CAUTION</b>
<ul style="list-style-type: none"><li>• <b>Permit only qualified persons to service the instrument</b></li><li>• <b>Before connecting or disconnecting any components, remove the power.</b></li><li>• <b>Failure to observe these precautions bodily harm or damage to or destruction of the equipment.</b></li></ul>

### 10.1. General

If the scale does not operate properly, find out the problem as possible. Determine whether the problem is constant or alternate. Be aware that problems can be caused by mechanical or electrical influences.

Check the following.

- Water
- Corrosive materials
- Vibrations or temperature or wind
- Physical damage

Check the scale cables for damage, and check all connections and connectors for any loose contact or incorrect connection

## Cleaning

- Disconnect the power before cleaning.
- Use a cloth with mild suds and light cleaning agents.
- Make sure that fluid not able to get into the device.
- Use a clean and soft cloth for rub off.

## 10.2. Error Codes

Error Code	Description	POSSIBLE CAUSES
Err 4	Exceed manual zero range (pressing  )	<ul style="list-style-type: none"> <li>• Goods on the platform</li> <li>• Overload, when zeroing the scale.</li> <li>• Improper calibration</li> <li>• Load cell problem</li> <li>• PCB problem</li> </ul>
Err 6	A/D Count out of the range	<ul style="list-style-type: none"> <li>• Platform not installed</li> <li>• Load cell problem</li> <li>• PCB problem</li> </ul>
Err 19	Exceed Auto Zero range When switch on the scale	<ul style="list-style-type: none"> <li>• Goods on the platform</li> <li>• Improper calibration</li> <li>• Load cell problem</li> <li>• PCB problem</li> </ul>

## 10.3. Determine the Problem

Determine whether the problem is in the PCB or the Load Cell

- Remove power from the system, and disconnect the load cell connection from the PCB
  - Connect the PCB to a load cell simulator
  - Reapply power and test the PCB
  - If problem goes away, its source is probably in the Load cell. Check the wiring, connector, load cell and mechanical components of the load cell.
- If problem persists, its source is probably in the PCB. Check the PCB voltages, connectors, cables and function programs

## 10.4. Check the Load cell

- Remove power from the system, and disconnect the PCB from the Load cell
- Check the moisture, or foreign material inside.
- Make sure all leads are connected and correctly.
- Check load cell for proper input and output resistances

### Load Cell Connections

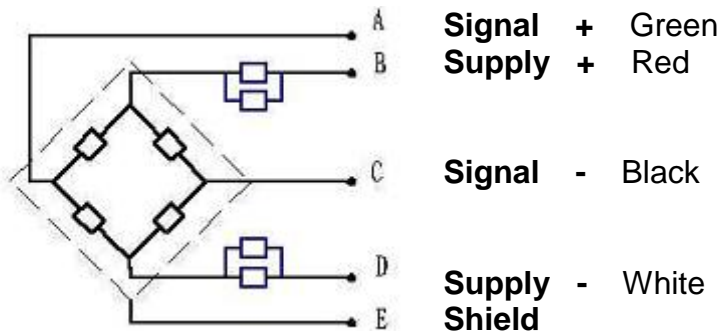

Measuring Points	Resistance
Red (+ Exc) to White (-Exc)	420 $\pm$ 20 $\Omega$
Green (+Sig) to Black (-Sig)	350 $\Omega$ $\pm$ 5 $\Omega$

## 10.5. Check PCB Voltages

If the problem is in the PCB, use a multimeter to check the following voltages

### 10.5.1 AC Power

Check the AC power socket out put voltage.

- Voltage must be a -20% and +10% of the normal AC voltage.

### 10.5.2 Adaptor Voltage

Check the adaptor output cable connector voltage

- Voltage must be minimum 9VDC and maximum 15VDC

### 10.5.3 PCB Input Voltage

Check the PCB input power connector voltage

- Voltage must be minimum 9VDC in to the pin AD+

### 10.5.4 Check Battery Voltage and Charging Voltage

1. Check the Battery Voltage,

- Voltage must be minimum 6VDC. If below the 6VDC connect the adaptor for charging
- The battery voltage below the 5.5VDC, replace the battery and install new 6V/3.4Ah battery.

2. Check the Battery Charging Voltage;

- Remove the battery connection terminals (Red and Black) from the battery.
- Connect the power and turn on the scale
- Voltage into the terminal minimum 6.5VDC

## 10.6 Trouble Shooting

Problems	Possible cause	Common Solutions
Display is blank. No self test	Mains power is turned off. Power supply faulty or not plugged. Internal battery is not charged. On/Off switch problem	Check power is getting inside the scale and on/off switch is working. Verify the voltages, which is on the power labels.
Blank display after self test	Pan not installed. Unstable weight, load cell damaged	Check the pans are installed correctly. Try to turning on again.
OL or -----	Maximum capacity exceeded. Load cell or mechanics damaged. Power supply faulty	Check the platform is installed correctly. Try to turn on the scale again. Do the calibration again
----- or NULL displayed	Weight is on the platform is below permissible limit. Pan not installed correctly. Power supply faulty. Load cell or mechanism faulty	Check the platform is installed correctly. Try to turn on the scale again. Do the calibration again

Display is unstable	Goods touching somewhere. Air variation or any vibrations. Temperature changed . Load cell or connections faulty. Power supply faulty	Check the scale is in acceptable location. Check the connectors and load cell. Check the power supply and battery
Weight value incorrect	Calibration error. Platform of load cell touching somewhere. Wrong weighing unit	Use accurate weight for to do the calibration Check the pan and load cell is installed proper and touching. Check the parameter settings. Check the load cell and connectors
Can not use full capacity	Over load protection stoppers or transport locks are not removed. Parameters are set incorrectly. AD problem. Load cell or mechanism damaged	Check the stoppers and locks under the platform. Check the weighing unit and parameter settings. Check the load cell.
Platform Corner Weight different	Over load protection stoppers or transport locks are not removed. Load cell or mechanism damaged	Check the stoppers and locks under the platform. Use accurate weight for to do the calibration Check the load cell.
Battery not charging	Mains voltage problem Charging circuit problem Battery Problem	Check the mains and adaptor. Check the battery. Check the charging circuit

## 12. DISPOSAL

### Disposing of the device



Do not dispose of the device in domestic waste. The device must be disposed of properly as electronic waste. Follow the national regulations which apply in your case. For further information, contact our service department at: [service@taiwanscale.com](mailto:service@taiwanscale.com)

### Batteries

Do not throw used batteries away in domestic waste. Dispose of batteries at collection points in the vicinity. When buying new batteries, select those low in harmful substances and containing no mercury (Hg), cadmium (Cd) or lead (Pb).



## 13. WARRANTY

A two-year warranty from date of delivery applies to defects attributable to poor materials or workmanship. All moveable parts batteries, cables, mains units, rechargeable batteries etc. are excluded. Defects which come under warranty will be made good for the customer at no charge on production of the receipt. No further claims can be entertained. The costs of transport in both directions will be borne by the customer should the equipment be located anywhere other than the customer's premises. In the event of transport damage, claims under warranty can be honoured only if the complete original packaging was used for any transport and the scale secured and attached in that packaging just as it was when originally packed. All the packaging should therefore be retained.

A claim under warranty will not be honoured if the equipment is opened by persons not expressly authorised by T-scale to do so. We would ask our customers abroad to contact their local sales agent in the event of a warranty matter.

# T-Scale



The company was founded in Taiwan in 1967 as Taiwan Scale Mfg Co., Ltd in order to produce Mechanical Weighing Instrument. Today, this privately owned company is recognized worldwide as a leading Electronic Weighing Scale Manufacturer. The core business of TSCALE is the development, manufacture, worldwide sales/marketing and service of electronic weighing instruments.

## The TSCALE products

- Medical Scale
- Counting Scale
- Tabletop Scale
- Retail Scale
- Precision Scale
- Pallet Scale
- Weighing Indicator
- Crane Scale
- Floor and Pallet Scale
- Accessory
- Software

TSCALE has its manufacturing unit in Kunshan, China, ISO 9001 certified company, **ODM** partner, more than 20 products have **OIML** certifications from Holland's NMI and Denmark's Delta.

---

**TScale Electronics Mfg. (Kunshan) Co., Ltd.**  
268, Zhujiawan Road, Kunshan, Jiangsu, China  
Tel : +86 512 57067900 / 57669080  
Fax: +86 512 5769508 / 57669100

**Taiwan Scale Mfg. Co., Ltd**  
282, Sec.3, Hoping W.Rd., Taipei, Taiwan  
Tel : +886 2 23068203  
Fax: +886 2 23044354