



**CTS (NINGBO) TESTING SERVICE TECHNOLOGY
INTERNATIONAL**

OPERATE ACCORDING TO ISO/IEC 17025

EMC TEST REPORT

TEST REPORT NUMBER : CGZ3160623-01026-E-D



CTS (Ningbo) Testing Service Technology Co., Ltd.
2/F., South Tower, Huoju Building, No.181, Canghai Road,
Jiangdong Science and Technology Park, Ningbo, Zhejiang, China

TEST REPORT	
EN 61000-6-3:2007+A1:2011+AC:2012	
Electromagnetic compatibility (EMC) —Part 6-3: Generic standards — Emission standard for residential, commercial and light-industrial environments	
EN 61000-6-1:2007	
Electromagnetic compatibility (EMC) —Part 6-1: Generic standards — Immunity for residential, commercial and light-industrial environments	
Report Reference No.	CGZ3160623-01026-E-D
Date of issue	02 July 2016
Testing Laboratory Name	CTS (Ningbo) Testing Service Technology Co., Ltd.
Address	GZ test site: A101, No.65, Zhuji Road, Tianhe District, Guangzhou, Guangdong, China.
Testing location/ procedure	Full application of Harmonised standards <input checked="" type="checkbox"/> Partial application of Harmonised standards <input type="checkbox"/> Other standard testing method <input type="checkbox"/>
Applicant's name	LW MEASUREMENTS EUROPE LTD.
Address	37 Building, B Zone, Pushang Park, Jinshan Industrial District, Fuzhou, Fujian Province, China
Test specification:	
Standard	EN 61000-6-3:2007+A1:2011+AC:2012, EN 61000-6-1:2007
Test Report Form No.	CTSEMC-1.0
TRF Originator	CTS (Ningbo) Testing Service Technology Co., Ltd.
Master TRF	Dated 2009-01
CTS (Ningbo) Testing Service Technology Co., Ltd. All rights reserved.	
This publication may be reproduced in whole or in part for non-commercial purposes as long as the CTS (Ningbo) Testing Service Technology Co., Ltd. is acknowledged as copyright owner and source of the material. CTS (Ningbo) Testing Service Technology Co., Ltd. takes no responsibility for and will not assume liability for damages resulting from the reader's interpretation of the reproduced material due to its placement and context.	
Test item description	ELECTRONIC SCALE
Trade Mark	FURI(TREE)
Manufacturer	FUZHOU FURI ELECTRONICS CO.,LTD.
Model/Type reference	FRH
Ratings	Battery 1.5V*6
Result	PASSED

Compiled by:

Kate zhang / File administrators

Supervised by:

Duke yang / Technique principal

Approved by:

Vincent yao / Manager

Copyright of this report is owned by Centre of Testing Service and may not be reproduced other than in full except with the written approval of the issuing Company.

CTS (Ningbo) Testing Service Technology Co., Ltd.

2/F., South Tower, Huoju Building, No.181, Canghai Road, Jiangdong Science and Technology Park, Ningbo, Zhejiang, China

Tel: +86-20-85543113 (32 lines)

Fax: +86-20-38780406

Complaint line: +86-20-85533471

E-mail: cts@cts-lab.com.cn

See Reverse For Terms And Conditions of Service



EMC -- TEST REPORT

Test Report No. : CGZ3160623-01026-E-D	<u>02 July 2016</u> Date of issue
--	--------------------------------------

Type / Model.....	FRH
EUT.....	ELECTRONIC SCALE
Applicant.....	LW MEASUREMENTS EUROPE LTD.
Address.....	37 Building, B Zone, Pushang Park, Jinshan Industrial District, Fuzhou, Fujian Province, China
Telephone.....	+86-591-83050561
Fax.....	+86-591-83050562
Contact.....	QIFU ZHOU
Manufacturer.....	FUZHOU FURI ELECTRONICS CO.,LTD.
Address.....	37 Building, B Zone, Pushang Park, Jinshan Industrial District, Fuzhou, Fujian Province, China
Telephone.....	+86-591-83050561
Fax.....	+86-591-83050562
Contact.....	QIFU ZHOU
Factory.....	FUZHOU FURI ELECTRONICS CO.,LTD.
Address.....	37 Building, B Zone, Pushang Park, Jinshan Industrial District, Fuzhou, Fujian Province, China
Telephone.....	+86-591-83050561
Fax.....	+86-591-83050562
Contact.....	QIFU ZHOU

Special description:

This is an additional test report which is based on the original report **CGZ3160623-01024-E**. There are no any difference among the models except for the applicant, product models and displace following identical model(s). After review, no additional test should be carried out.

The test report merely corresponds to the test sample.
It is not permitted to copy extracts of these test result without the written permission of the test laboratory.

TABLE OF CONTENTS

Description	Page
1 TEST STANDARDS.....	4
2 SUMMARY	4
2.1 GENERAL REMARKS.....	4
2.2 FINAL ASSESSMENT	4
3 EQUIPMENT UNDER TEST	5
3.1 Power supply system utilised	5
3.2 Short description of the Equipment under Test (EUT).....	5
3.3 EUT operation mode	5
3.4 EUT configuration	6
3.5 Performance level	6
3.6 Definition related to the performance level	6
4 TEST ENVIRONMENT.....	7
4.1 Address of the test laboratory	7
4.2 Test facility.....	7
4.3 Environmental conditions	7
4.4 Definitions of symbols used in this test report.....	7
4.5 Statement of the measurement uncertainty	7
4.6 Measurement Uncertainty	8
4.7 Test Description	8
5 TEST CONDITIONS AND RESULTS	9
5.1 Radiated disturbance (electric field)	9
5.2 Electrostatic discharge	15
5.3 Radiated, radio-frequency, electromagnetic field.....	17
5.4 Power frequency magnetic field	19
6 USED TEST EQUIPMENT.....	21
7 TEST PHOTOGRAPHS	22
7.1. Photo of radiated emission measurement (R.E. Electric field).....	22
7.2. Photo of electrostatic discharge Immunity measurement (E.S.D.).....	22
7.3. Photo of RF field strength Immunity measurement (R.S.).....	22
7.4. Photo of PFM field immunity measurement (P.F.M.F.).....	23
8 EXTERNAL AND INTERNAL PHOTOS OF THE EUT.....	24
9 Manufacturer/ Approval holder Declaration	29

Copyright of this report is owned by Centre of Testing Service and may not be reproduced other than in full except with the written approval of the issuing Company.

CTS (Ningbo) Testing Service Technology Co., Ltd.

2/F., South Tower, Huoju Building, No.181, Canghai Road, Jiangdong Science and Technology Park, Ningbo, Zhejiang, China

Tel: +86-20-85543113 (32 lines)

Fax: +86-20-38780406

Complaint line: +86-20-85533471

E-mail: cts@cts-lab.com.cn

See Reverse For Terms And Conditions of Service

1 TEST STANDARDS

The tests were performed according to following standards:

EN 61000-6-3:2007+A1:2011+AC:2012 Electromagnetic compatibility (EMC) —Part 6-3: Generic standards — Emission standard for residential, commercial and light-industrial environments

EN 61000-6-1:2007 Electromagnetic compatibility (EMC) —Part 6-1: Generic standards — Immunity for residential, commercial and light-industrial environments

2 SUMMARY

2.1 GENERAL REMARKS

Date of receipt of test sample	23 June 2016
Testing commenced on	23 ~ 24 June 2016
Testing concluded on	02 July 2016

2.2 FINAL ASSESSMENT

The EMC requirements pertaining to the technical standards and tested operation modes are

- fulfilled.
- **not** fulfilled.

The equipment under test

- fulfils the EMC requirements cited on page 1.
- **does not** fulfil the EMC requirements cited on page 1.



3 EQUIPMENT UNDER TEST

3.1 Power supply system utilised

Power supply voltage: Battery 1.5V*6
 Other (Specified blank below)

3.2 Short description of the Equipment under Test (EUT)

Number of tested samples: 1
Serial number: Prototype

3.3 EUT operation mode

The equipment under test was operated during the measurement under the following conditions:

- Normal

Operating Mode: Normal

Emissions tests.....: According to EN 61000-6-3, searching for the highest disturbance.

Immunity tests : According to EN 61000-6-1, searching for the highest susceptibility.

3.4 EUT configuration

(The CDF filled by the applicant can be viewed at the test laboratory.)

The following peripheral devices and interface cables were connected during the measurement:

Not Applicable

3.5 Performance level

The test results shall be classified in terms of the loss of function or degradation of performance of the equipment under test, relative to a performance level defined by its manufacturer or the requestor of the test, or agreed between the manufacturer and the purchaser of the product.

3.6 Definition related to the performance level

- based on the used product standard
- based on the declaration of the manufacturer, requestor or purchaser

Criterion A:

Definition: normal performance within limits specified by the manufacturer, requestor or purchaser:

Criterion B:

Definition: temporary loss of function or degradation of performance which ceases after the disturbance ceases, and from which the equipment under test recovers its normal performance, without operator intervention:

Criterion C:

Definition: temporary loss of function or degradation of performance, the correction of which requires operator intervention:

Criterion D:

Definition: loss of function or degradation of performance, which is not recoverable, owing to damage to hardware or software, or loss of data:

4 TEST ENVIRONMENT

4.1 Address of the test laboratory

GZ test site: A101, No.65, Zhuji Road, Tianhe District, Guangzhou, Guangdong, China

Tel: +86-20-85543113 (32 lines)

Fax: +86-20-38780406

4.2 Test facility

The test facility is recognized, certified, or accredited by the following organizations:

CNAS-Lab Code: L3394

CTS (Ningbo) Testing Service Technology Co., Ltd. has been assessed and proved to be in compliance with CNAS-CL01: 2006 Accreditation Criteria for Testing and Calibration Laboratories (identical to ISO/IEC 17025: 2005 General Requirements) for the Competence of Testing and Calibration Laboratories.

IC-Registration No.: 8374A

The 3m Alternate Test Site of CTS (Ningbo) Testing Service Technology Co., Ltd. has been registered by Certification and Engineering Bureau of Industry Canada for the performance of radiated measurements with Registration No. 8374A on May 22, 2014.

FCC-Registration No.: 971995

CTS (Ningbo) Testing Service Technology Co., Ltd. EMC Laboratory has been registered and fully described in a report filed with the FCC (Federal Communications Commission). The acceptance letter from the FCC is maintained in our files. Registration No.971995, July 13, 2012.

4.3 Environmental conditions

During the measurement the environmental conditions were within the listed ranges:

Temperature:	15~35 ° C
Humidity:	25~75 %
Atmospheric pressure:	86~106 kPa

4.4 Definitions of symbols used in this test report

- - The black square indicates that the listed condition, standard or equipment is applicable for this report.
- - The empty square indicates that the listed condition, standard or equipment is **not** applicable for this report.

4.5 Statement of the measurement uncertainty

The data and results referenced in this document are true and accurate. The reader is cautioned that there may be errors within the calibration limits of the equipment and facilities. The measurement uncertainty was calculated for all measurements listed in this test report acc. to CISPR 16 - 4 "Specification for radio disturbance and immunity measuring apparatus and methods – Part 4: Uncertainty in EMC Measurements" and is documented in the CTS quality system acc. to DIN EN ISO/IEC 17025. Furthermore, component and process variability of devices similar to that tested may result in additional deviation. The manufacturer has the sole responsibility of continued compliance of the device.

Copyright of this report is owned by Centre of Testing Service and may not be reproduced other than in full except with the written approval of the issuing Company.

CTS (Ningbo) Testing Service Technology Co., Ltd.

2/F., South Tower, Huoju Building, No.181, Canghai Road, Jiangdong Science and Technology Park, Ningbo, Zhejiang, China

Tel: +86-20-85543113 (32 lines)

Fax: +86-20-38780406

Complaint line: +86-20-85533471

E-mail: cts@cts-lab.com.cn

See Reverse For Terms And Conditions of Service

4.6 Measurement Uncertainty

Test Item	Frequency Range	Uncertainty	Note
Conduction disturbance	150kHz~30MHz	±1.22dB	(1)
Power disturbance	30MHz~300MHz	±1.38dB	(1)
Radiation emission (3m)	30MHz~300MHz	±3.14dB	(1)
	300MHz~1000MHz	±3.18dB	(1)

- (1) This uncertainty represents an expanded uncertainty expressed at approximately the 95% confidence level using a coverage factor of k=2.
- (2) The actual EUT tested items in this test report, only applies to this "measurement uncertainty" in part / all of the corresponding data.

4.7 Test Description

4.7.1 Description of Standards and Results

EMISSION (EN 61000-6-3:2007+A1:2011+AC:2012)			
Description of Test Item	Standard	Limits	Results
Conducted disturbance at mains terminals	EN 61000-6-3:2007+A1:2011+AC:2012	-----	N/A
Conducted disturbance at telecommunication port	EN 61000-6-3:2007+A1:2011+AC:2012	-----	N/A
Radiated disturbance	EN 61000-6-3:2007+A1:2011+AC:2012	-----	PASS
Harmonic current emissions	EN 61000-3-2:2014	Class A	N/A
Voltage fluctuations & flicker	EN 61000-3-3:2013	-----	N/A
IMMUNITY (EN 61000-6-1:2007)			
Description of Test Item	Basic Standard	Performance Criteria	Results
Electrostatic discharge (ESD)	IEC 61000-4-2: 2008	B	PASS
Radio-frequency, Continuous radiated disturbance	IEC 61000-4-3:2006 +A1:2007+A2:2010	A	PASS
Electrical fast transient (EFT)	IEC 61000-4-4:2012	B	N/A
Surge (Input a.c. power ports)	IEC 61000-4-5: 2014	B	N/A
Radio-frequency, Continuous conducted disturbance	IEC 61000-4-6: 2013	A	N/A
Power frequency magnetic field	IEC 61000-4-8: 2009	A	PASS
Voltage dips, >95% reduction	IEC 61000-4-11: 2004	B	N/A
Voltage dips, 30% reduction		B	N/A
Voltage interruptions		C	N/A
N/A is an abbreviation for Not Applicable.			

Copyright of this report is owned by Centre of Testing Service and may not be reproduced other than in full except with the written approval of the issuing Company.

CTS (Ningbo) Testing Service Technology Co., Ltd.

2/F., South Tower, Huoju Building, No.181, Canghai Road, Jiangdong Science and Technology Park, Ningbo, Zhejiang, China

Tel: +86-20-85543113 (32 lines)

Fax: +86-20-38780406

Complaint line: +86-20-85533471

E-mail: cts@cts-lab.com.cn

See Reverse For Terms And Conditions of Service

5 TEST CONDITIONS AND RESULTS

5.1 Radiated disturbance (electric field)

For test instruments and accessories used see section 6 part 6.1.

5.1.1 Description of the test location

Test location : Semi-Anechoic chamber

Test disturbance: 3 Meter

5.1.2 Description of the test set-up

5.1.2.1 Operating Condition

The EUT is normal during the test, and the results of the maximum emanation are recorded

5.1.2.2 Block Diagram of Test Setup

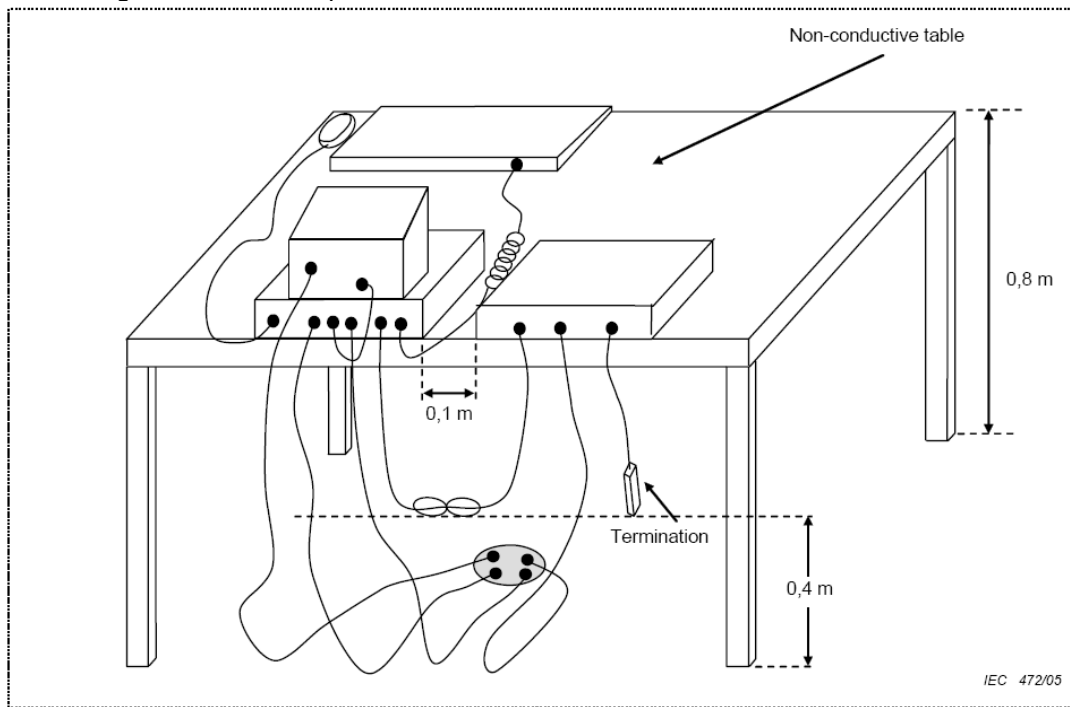

5.1.3 Limits of disturbance

Frequency (MHz)	Distance (Meters)	Field Strengths Limits (dB μ V/m)
30 ~ 230	3	40
230 ~ 1000	3	47

Note: (1) The tighter limit shall apply at the edge between two frequency bands.

(2) Distance refers to the distance in meters between the test instrument antenna and the closest point of any part of the E.U.T.

5.1.4 Test result

The requirements are	Fulfilled
Band width	120kHz
Frequency range	30 MHz - 1000 MHz
Min. limit margin	>0.72 dB at 30 - 1000 MHz

Remarks: The limits are kept. For detailed results, please see the following page(s).

5.1.5 Test protocol

Test point: Operation mode Remarks:	Horizontal Normal	Result:	<input checked="" type="checkbox"/> - passed <input type="checkbox"/> - not passed
EUT	ELECTRONIC SCALE		
Operating Condition	Battery 1.5V*6		
Test Condition	Ambient Temperature: 24°C Humidity: 56%		
Operator	Clark		
MODEL NO.	FRH		

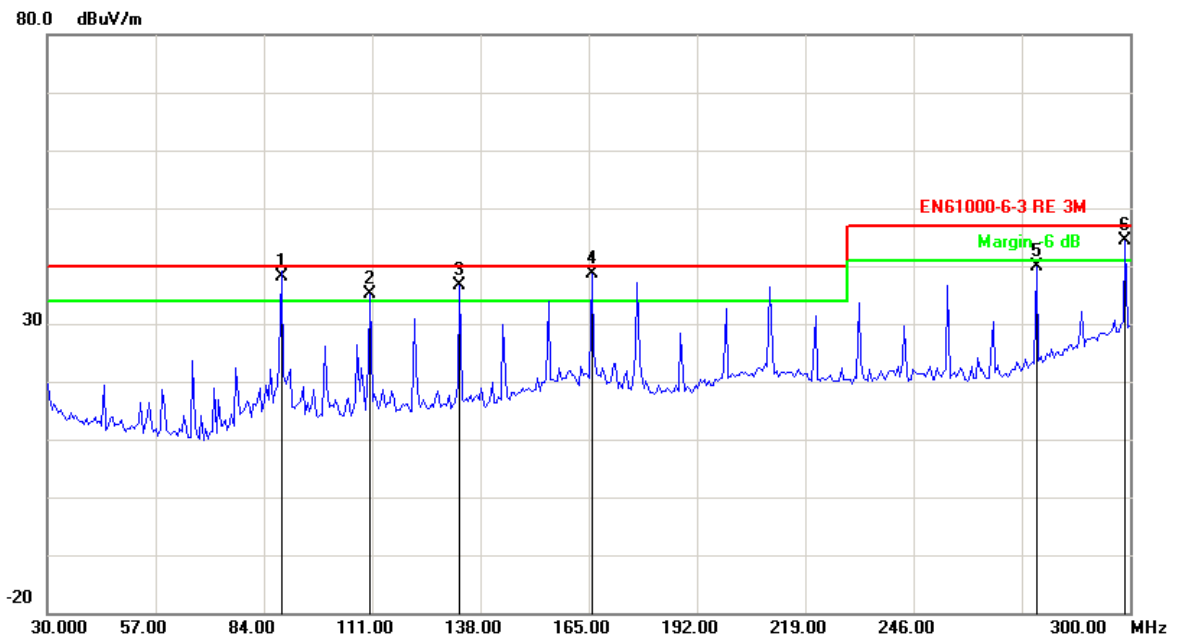

No.	Frequency (MHz)	Factor (dB/m)	Reading (dBuV)	Level (dBuV/m)	Limit (dBuV/m)	Margin (dB)	Det.
1	88.4368	-19.27	57.50	38.23	40.00	-1.77	QP
2	110.6212	-17.26	52.33	35.07	40.00	-4.93	QP
3	132.8056	-16.11	52.66	36.55	40.00	-3.45	QP
4	165.8116	-15.98	54.55	38.57	40.00	-1.43	QP
5	276.7335	-8.10	47.86	39.76	47.00	-7.24	QP
6	298.9178	-1.71	46.20	44.49	47.00	-2.51	QP

Copyright of this report is owned by Centre of Testing Service and may not be reproduced other than in full except with the written approval of the issuing Company.

CTS (Ningbo) Testing Service Technology Co., Ltd.
 2/F., South Tower, Huoju Building, No.181, Canghai Road, Jiangdong Science and Technology Park, Ningbo, Zhejiang, China
 Tel: +86-20-85543113 (32 lines) Fax: +86-20-38780406
 Complaint line: +86-20-85533471 E-mail: cts@cts-lab.com.cn

See Reverse For Terms And Conditions of Service

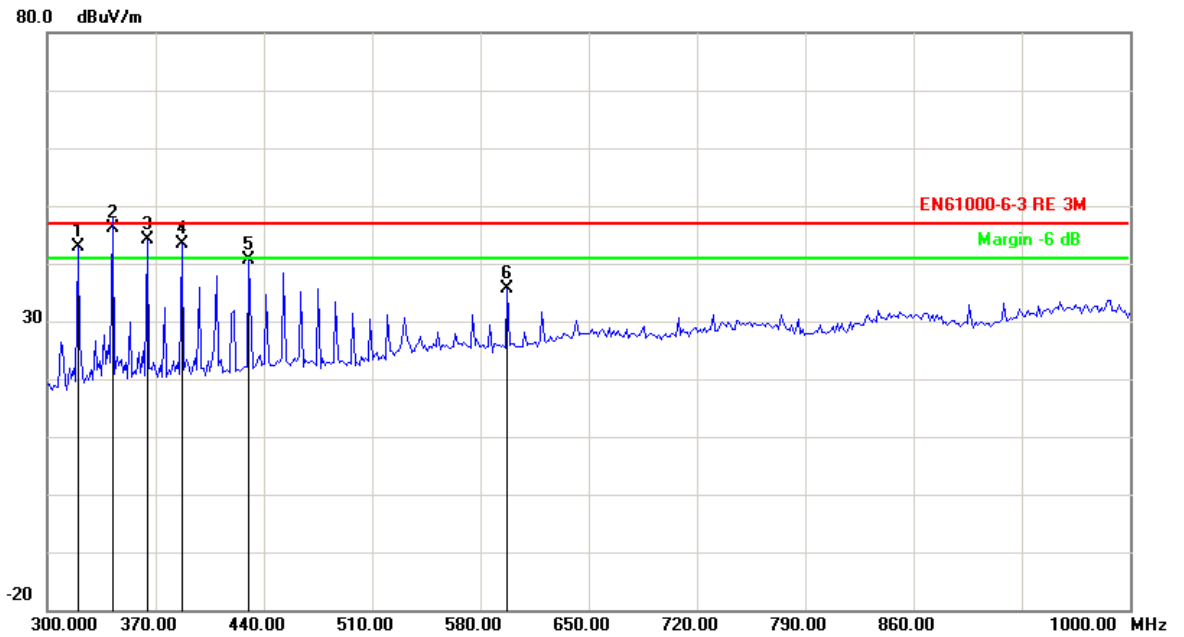

No.	Frequency (MHz)	Factor (dB/m)	Reading (dBuV)	Level (dBuV/m)	Limit (dBuV/m)	Margin (dB)	Det.
1	319.6392	-12.73	55.51	42.78	47.00	-4.22	QP
2	342.0842	-11.71	57.84	46.13	47.00	-0.87	QP
3	364.5290	-11.11	55.20	44.09	47.00	-2.91	QP
4	386.9739	-10.73	54.12	43.39	47.00	-3.61	QP
5	430.4609	-9.26	49.97	40.71	47.00	-6.29	QP
6	597.3947	-5.56	41.29	35.73	47.00	-11.27	QP

Copyright of this report is owned by Centre of Testing Service and may not be reproduced other than in full except with the written approval of the issuing Company.

CTS (Ningbo) Testing Service Technology Co., Ltd.

2/F., South Tower, Huoju Building, No.181, Canghai Road, Jiangdong Science and Technology Park, Ningbo, Zhejiang, China

Tel: +86-20-85543113 (32 lines)

Fax: +86-20-38780406

Complaint line: +86-20-85533471

E-mail: cts@cts-lab.com.cn

See Reverse For Terms And Conditions of Service

Test point: Operation mode Remarks:	Vertical Normal	Result:	<input checked="" type="checkbox"/> - passed <input type="checkbox"/> - not passed
---	--------------------	---------	---

EUT	ELECTRONIC SCALE
MODEL NO.	FRH
Operating Condition	Battery 1.5V*6
Test Condition	Ambient Temperature: 24°C Humidity: 56%
Operator	Clark

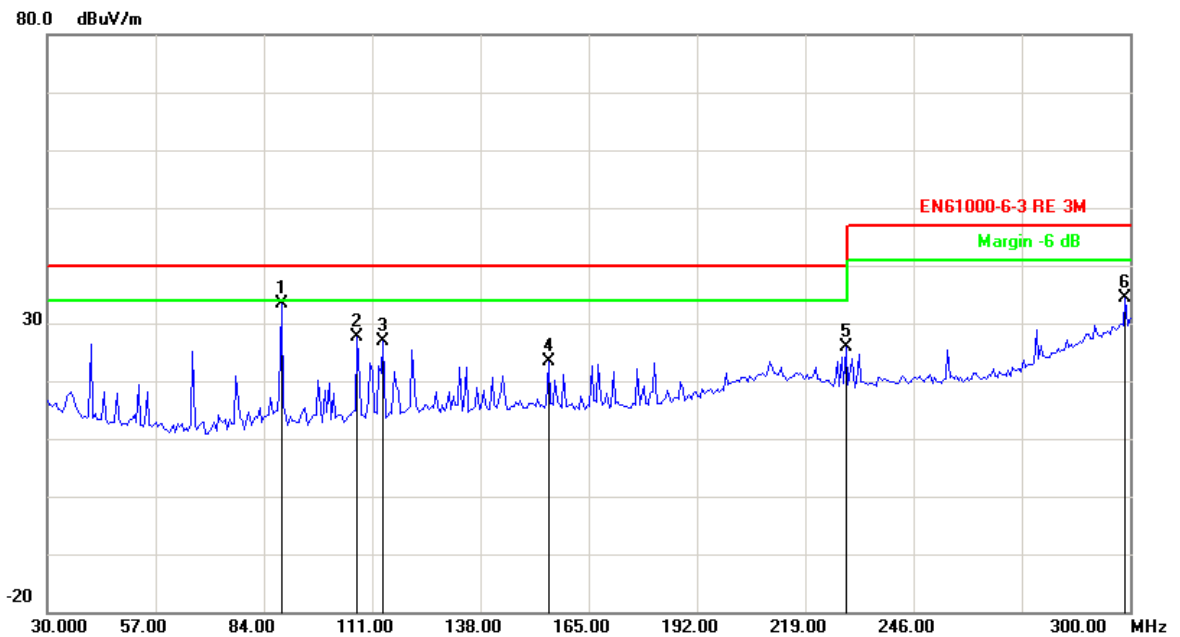

No.	Frequency (MHz)	Factor (dB/m)	Reading (dBuV)	Level (dBuV/m)	Limit (dBuV/m)	Margin (dB)	Det.
1	88.4369	-19.27	52.56	33.29	40.00	-6.71	QP
2	107.3747	-17.54	45.06	27.52	40.00	-12.48	QP
3	113.8677	-17.08	44.00	26.92	40.00	-13.08	QP
4	154.9900	-15.96	39.28	23.32	40.00	-16.68	QP
5	229.1182	-11.59	37.36	25.77	40.00	-14.23	QP
6	298.9178	-1.71	36.15	34.44	47.00	-12.56	QP

Copyright of this report is owned by Centre of Testing Service and may not be reproduced other than in full except with the written approval of the issuing Company.

CTS (Ningbo) Testing Service Technology Co., Ltd.

2/F., South Tower, Huoju Building, No.181, Canghai Road, Jiangdong Science and Technology Park, Ningbo, Zhejiang, China

Tel: +86-20-85543113 (32 lines)

Fax: +86-20-38780406

Complaint line: +86-20-85533471

E-mail: cts@cts-lab.com.cn

See Reverse For Terms And Conditions of Service

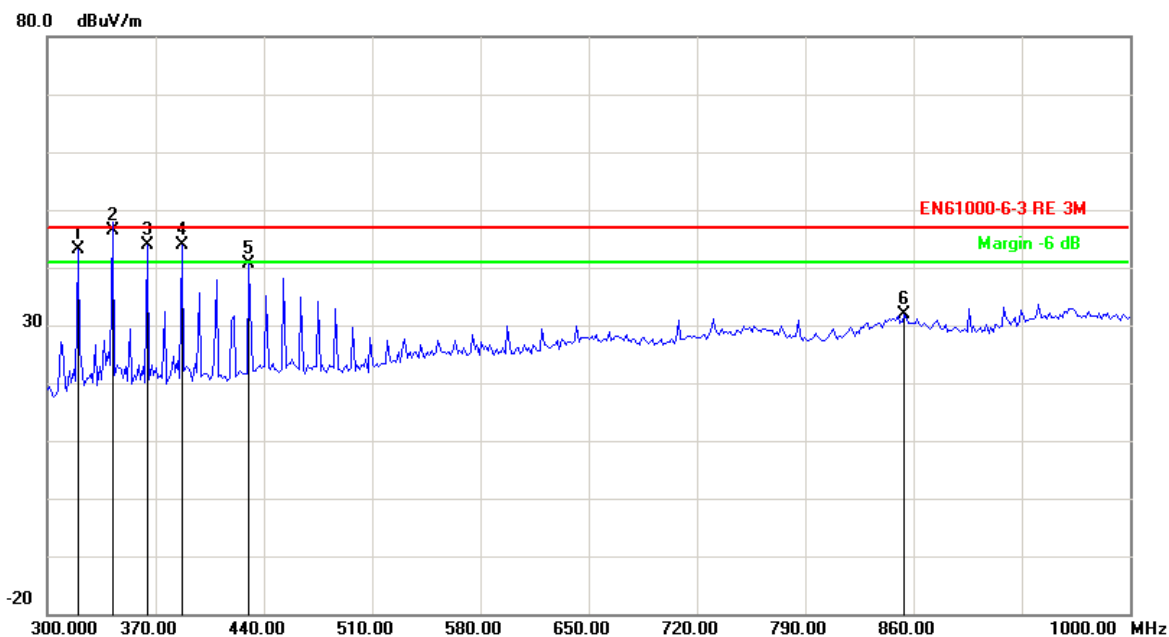

No.	Frequency (MHz)	Factor (dB/m)	Reading (dBuV)	Level (dBuV/m)	Limit (dBuV/m)	Margin (dB)	Det.
1	319.6392	-12.73	55.80	43.07	47.00	-3.93	QP
2	342.0841	-11.71	57.99	46.28	47.00	-0.72	QP
3	364.5290	-11.11	55.02	43.91	47.00	-3.09	QP
4	386.9738	-10.73	54.55	43.82	47.00	-3.18	QP
5	430.4609	-9.26	49.99	40.73	47.00	-6.27	QP
6	854.1082	-0.41	32.37	31.96	47.00	-15.04	QP

Note: Level=Reading+Factor. Margin= Limit-Level

Copyright of this report is owned by Centre of Testing Service and may not be reproduced other than in full except with the written approval of the issuing Company.

CTS (Ningbo) Testing Service Technology Co., Ltd.

2/F., South Tower, Huoju Building, No.181, Canghai Road, Jiangdong Science and Technology Park, Ningbo, Zhejiang, China

Tel: +86-20-85543113 (32 lines)

Fax: +86-20-38780406

Complaint line: +86-20-85533471

E-mail: cts@cts-lab.com.cn

See Reverse For Terms And Conditions of Service

5.2 Electrostatic discharge

For test instruments and accessories used see section 6 part 6.2.

5.2.1 Description of the test location

Test location :	Test location no. 2
Power supply:	Battery 1.5V*6
Test condition:	Ambient Temperature: 24°C, Humidity:56%
Date of test :	23 ~ 24 June 2016
Operator :	Clark

5.2.2 Severity of levels electrostatic discharge

5.2.2.1 Severity level: Contact discharge at $\pm 4KV$ air discharge at $\pm 8KV$

Level	Test Voltage Contact Discharge (kV)	Test Voltage Air Discharge (kV)
1	2	2
2	4	4
3	6	8
4	8	15
X	Special	Special

5.2.2.2 Performance criterion: B

5.2.3 Description of the test set-up

5.2.3.1 Operating Condition

The EUT is normal during the test, and the results of the maximum emanation are recorded

5.2.3.2 Block Diagram of Test Setup

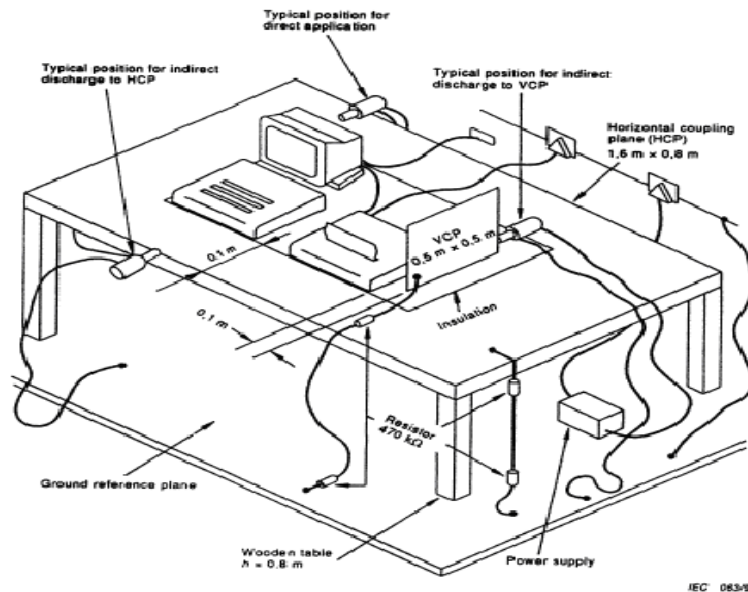

Copyright of this report is owned by Centre of Testing Service and may not be reproduced other than in full except with the written approval of the issuing Company.

CTS (Ningbo) Testing Service Technology Co., Ltd.

2/F., South Tower, Huoju Building, No.181, Canghai Road, Jiangdong Science and Technology Park, Ningbo, Zhejiang, China

Tel: +86-20-85543113 (32 lines)

Fax: +86-20-38780406

Complaint line: +86-20-85533471

E-mail: cts@cts-lab.com.cn

See Reverse For Terms And Conditions of Service

5.2.4 Test specification:

Contact discharge voltage:	<input checked="" type="checkbox"/> 2 kV	<input checked="" type="checkbox"/> 4 kV	
Air discharge voltage:	<input checked="" type="checkbox"/> 2 kV	<input checked="" type="checkbox"/> 4 kV	<input checked="" type="checkbox"/> 8 kV
Discharge impedance:	<input checked="" type="checkbox"/> 330 Ω / 150 pF		
Discharge factor:	<input checked="" type="checkbox"/> ≥ 1 sec.		
Number of discharges:	<input checked="" type="checkbox"/> ≥ 10		
Type of discharge:	Direct discharge	<input checked="" type="checkbox"/> Air discharge	
		<input checked="" type="checkbox"/> Contact discharge	
	Indirect discharge	<input checked="" type="checkbox"/> Contact discharge	
Polarity:	<input checked="" type="checkbox"/> Positive	<input checked="" type="checkbox"/> Negative	
Discharge location:	<input checked="" type="checkbox"/> see photo documentation of the test set-up		
	<input checked="" type="checkbox"/> all external locations accessible by hand		
	<input checked="" type="checkbox"/> horizontal plate (HCP)		
	<input checked="" type="checkbox"/> vertical coupling plate (VCP)		

5.2.5 Test result

The requirements are **Fulfilled**

Performance Criterion: **B**

Remarks: During the test no deviation was detected to the selected operation mode(s).

5.3 Radiated, radio-frequency, electromagnetic field

For test instruments and accessories used see section 6 part 6.3.

5.3.1 Description of the test location

Test location :	Test location no. 2
Power supply:	Battery 1.5V*6
Test condition:	Ambient Temperature: 24°C, Humidity:56%
Date of test :	23 ~ 24 June 2016
Operator :	Clark

5.3.2 Severity levels of radiated, Radio-frequency, electromagnetic field

5.3.2.1 Severity level: 3V/m and 1V/m

Level	Field strenght(V/m)
1	1
2	3
3	10
X	Special

5.3.2.2 Performance criterion: A

5.3.3 Description of the test set-up

5.3.3.1 Operating Condition

The EUT is normal during the test, and the results of the maximum emanation are recorded

5.3.3.2 Block Diagram of Test Setup

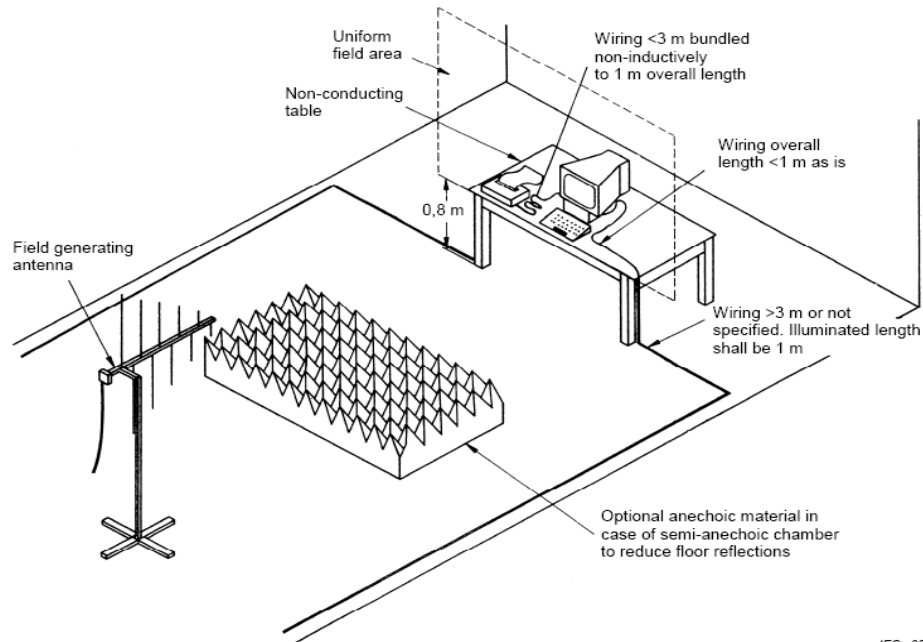

IEC 034/06

Copyright of this report is owned by Centre of Testing Service and may not be reproduced other than in full except with the written approval of the issuing Company.

CTS (Ningbo) Testing Service Technology Co., Ltd.

2/F., South Tower, Huoju Building, No.181, Canghai Road, Jiangdong Science and Technology Park, Ningbo, Zhejiang, China

Tel: +86-20-85543113 (32 lines)

Fax: +86-20-38780406

Complaint line: +86-20-85533471

E-mail: cts@cts-lab.com.cn

See Reverse For Terms And Conditions of Service

5.3.4 Test specification:

Frequency range:	■ 80 MHz to 1000 MHz
Field strength:	■ 3 V/m
EUT - antenna separation:	■ 3 m
Modulation:	■ AM: 80 % ■ sinusoidal 1000Hz
Frequency step:	■ 1 % with 3 s dwell time
Antenna polarisation:	■ horizontal ■ vertical

Frequency range:	■ 1400 MHz to 2000 MHz
Field strength:	■ 3 V/m
EUT - antenna separation:	■ 3 m
Modulation:	■ AM: 80 % ■ sinusoidal 1000Hz
Frequency step:	■ 1 % with 3 s dwell time
Antenna polarisation:	■ horizontal ■ vertical

Frequency range:	■ 2000 MHz to 2700 MHz
Field strength:	■ 1 V/m
EUT - antenna separation:	■ 3 m
Modulation:	■ AM: 80 % ■ sinusoidal 1000Hz
Frequency step:	■ 1 % with 3 s dwell time
Antenna polarisation:	■ horizontal ■ vertical

5.3.5 Test result

The requirements are **Fulfilled**

Performance Criterion: **A**

Remarks: During the test no deviation was detected to the selected operation mode(s).

Copyright of this report is owned by Centre of Testing Service and may not be reproduced other than in full except with the written approval of the issuing Company.

CTS (Ningbo) Testing Service Technology Co., Ltd.

2/F., South Tower, Huoju Building, No.181, Canghai Road, Jiangdong Science and Technology Park, Ningbo, Zhejiang, China

Tel: +86-20-85543113 (32 lines)

Fax: +86-20-38780406

Complaint line: +86-20-85533471

E-mail: cts@cts-lab.com.cn

See Reverse For Terms And Conditions of Service

5.4 Power frequency magnetic field

For test instruments and accessories used see section 6 part 6.4.

5.4.1 Description of the test location

Test location :	Test location no. 2
Power supply:	Battery 1.5V*6
Test condition:	Ambient Temperature: 24°C, Humidity:56%
Date of test :	23 ~ 24 June 2016
Operator :	Clark

5.4.2 Severity levels of magnetic field immunity

5.4.2.1 Severity Level: 3A/m

Level	Magnetic Field Strength (A/m)
1	1
2	3
3	10
4	30
5	100
X	Special

5.4.2.2 Performance Criterion: A

5.4.3 Description of the test set-up

5.4.3.1 Operating Condition

The EUT is normal during the test, and the results of the maximum emanation are recorded

5.4.3.2 Block Diagram of Test Setup

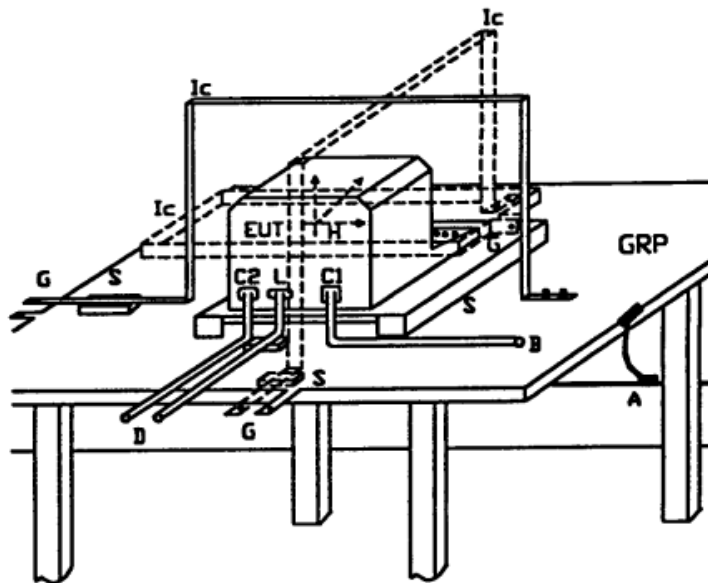

Copyright of this report is owned by Centre of Testing Service and may not be reproduced other than in full except with the written approval of the issuing Company.

CTS (Ningbo) Testing Service Technology Co., Ltd.

2/F., South Tower, Huoju Building, No.181, Canghai Road, Jiangdong Science and Technology Park, Ningbo, Zhejiang, China

Tel: +86-20-85543113 (32 lines)

Fax: +86-20-38780406

Complaint line: +86-20-85533471

E-mail: cts@cts-lab.com.cn

See Reverse For Terms And Conditions of Service

5.4.4 Test specification:

Test frequency:	■ 50 Hz		
Continuous field:	■ 3 A/m		
Duration (Continuous field):	■ 60 s each Axis		
Short duration (1-3s):	■ 3 S		
Axis:	■ x-axis	■ y-axis	■ z-axis

5.4.5 Test result

The requirements are **Fulfilled**

Performance Criterion: **A**

Remarks: During the test no deviation was detected to the selected operation mode(s).

6 USED TEST EQUIPMENT

6.1

Radiated Emission(Electric field)					
Item	Test Equipment	Manufacturer	Model No.	Serial No.	Last Cal.
1	Signal analyzer	ROHDE & SCHWARZ	FSIQ26	100311	2016/03/24
2	EMI Test Receiver	ROHDE & SCHWARZ	ESVS 10	842885/001	2015/10/30
3	Biconical Antenna	ROHDE & SCHWARZ	HK116	100221	2016/03/26
4	Log per Antenna	ROHDE & SCHWARZ	HL223	100226	2016/03/26
5	Log per Antenna	ROHDE & SCHWARZ	HL050	100186	2016/03/26
6	Pre-Amplifier	EMC	EMC330	980113	2016/03/24
7	Pre-Amplifier	EMC	EMC012645	980114	2016/03/24
8	EMI Test Software	Farad	EZ-EMC	N/A	N/A

6.2

Electrostatic Discharge					
Item	Test Equipment	Manufacturer	Model No.	Serial No.	Last Cal.
1	ESD Simulator	Schlöder	SESD 200	0302016	2016/03/28

6.3

RF Field Strength Susceptibility					
Item	Test Equipment	Manufacturer	Model No.	Serial No.	Last Cal.
1	Signal Generator	ROHDE & SCHWARZ	SMY 01	843215/014	2015/10/30
2	Signal Generator	ROHDE & SCHWARZ	SML03	102986	2015/10/30
3	Amplifier	KALMUS	713FC	7385-1	2015/10/30
4	Power Meter	ROHDE & SCHWARZ	NRVS	842856/049	2015/10/30
5	Field Probe	ETS	HI-6005	00075047	2015/11/10
6	RS Test Software	Farad	EZ-RS	N/A	N/A

6.4

Power Frequency Magnetic Field Susceptibility					
Item	Test Equipment	Manufacturer	Model No.	Serial No.	Last Cal.
1	Power frequency mag-field generator System	EM TEST	EMS61000-8K	409001	2015/10/30

Copyright of this report is owned by Centre of Testing Service and may not be reproduced other than in full except with the written approval of the issuing Company.

CTS (Ningbo) Testing Service Technology Co., Ltd.

2/F., South Tower, Huoju Building, No.181, Canghai Road, Jiangdong Science and Technology Park, Ningbo, Zhejiang, China

Tel: +86-20-85543113 (32 lines)

Fax: +86-20-38780406

Complaint line: +86-20-85533471

E-mail: cts@cts-lab.com.cn

See Reverse For Terms And Conditions of Service

7 TEST PHOTOGRAPHS

7.1. Photo of radiated emission measurement (R.E. Electric field)

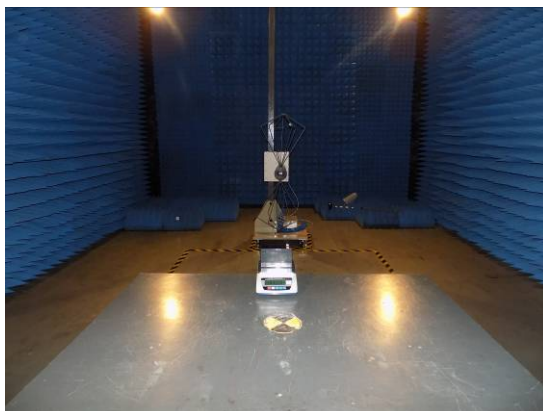

7.2. Photo of electrostatic discharge Immunity measurement (E.S.D.)

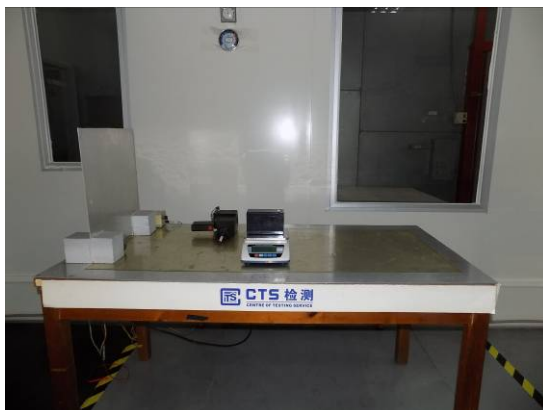

7.3. Photo of RF field strength Immunity measurement (R.S.)



Copyright of this report is owned by Centre of Testing Service and may not be reproduced other than in full except with the written approval of the issuing Company.

CTS (Ningbo) Testing Service Technology Co., Ltd.

2/F., South Tower, Huoju Building, No.181, Canghai Road, Jiangdong Science and Technology Park, Ningbo, Zhejiang, China

Tel: +86-20-85543113 (32 lines)

Fax: +86-20-38780406

Complaint line: +86-20-85533471

E-mail: cts@cts-lab.com.cn

See Reverse For Terms And Conditions of Service

7.4. Photo of PFM field immunity measurement (P.F.M.F.)

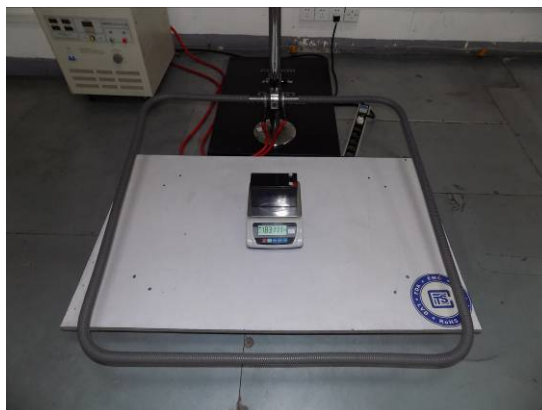

Copyright of this report is owned by Centre of Testing Service and may not be reproduced other than in full except with the written approval of the issuing Company.

CTS (Ningbo) Testing Service Technology Co., Ltd.

2/F., South Tower, Huoju Building, No.181, Canghai Road, Jiangdong Science and Technology Park, Ningbo, Zhejiang, China

Tel: +86-20-85543113 (32 lines)

Fax: +86-20-38780406

Complaint line: +86-20-85533471

E-mail: cts@cts-lab.com.cn

See Reverse For Terms And Conditions of Service

8 EXTERNAL AND INTERNAL PHOTOS OF THE EUT



External view 1



External view 2



External view 3

Copyright of this report is owned by Centre of Testing Service and may not be reproduced other than in full except with the written approval of the issuing Company.

CTS (Ningbo) Testing Service Technology Co., Ltd.

2/F., South Tower, Huoju Building, No.181, Canghai Road, Jiangdong Science and Technology Park, Ningbo, Zhejiang, China

Tel: +86-20-85543113 (32 lines)

Fax: +86-20-38780406

Complaint line: +86-20-85533471

E-mail: cts@cts-lab.com.cn

See Reverse For Terms And Conditions of Service

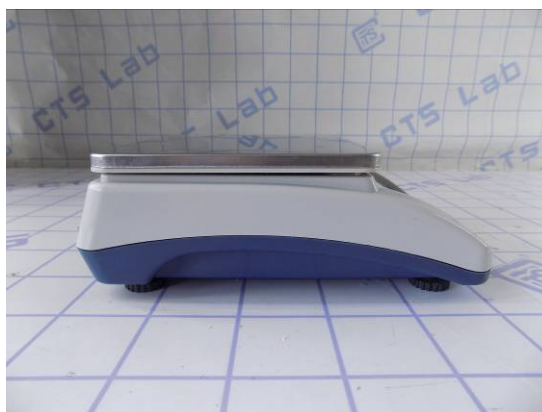

External view 4



External view 5



External view 6

Copyright of this report is owned by Centre of Testing Service and may not be reproduced other than in full except with the written approval of the issuing Company.

CTS (Ningbo) Testing Service Technology Co., Ltd.

2/F., South Tower, Huoju Building, No.181, Canghai Road, Jiangdong Science and Technology Park, Ningbo, Zhejiang, China

Tel: +86-20-85543113 (32 lines)

Fax: +86-20-38780406

Complaint line: +86-20-85533471

E-mail: cts@cts-lab.com.cn

See Reverse For Terms And Conditions of Service



Internal view 1

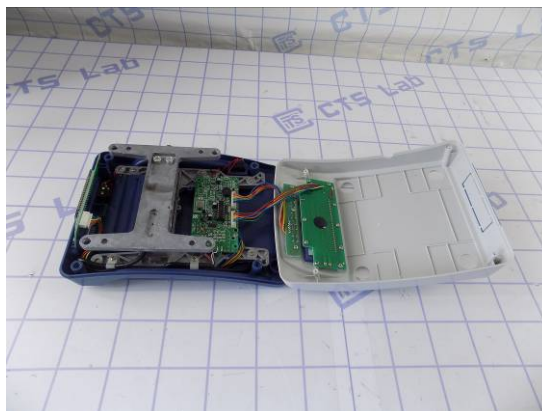

Internal view 2

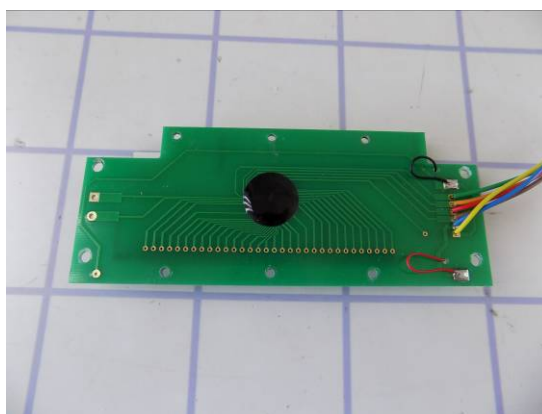

PCB view 1.1

Copyright of this report is owned by Centre of Testing Service and may not be reproduced other than in full except with the written approval of the issuing Company.

CTS (Ningbo) Testing Service Technology Co., Ltd.

2/F., South Tower, Huoju Building, No.181, Canghai Road, Jiangdong Science and Technology Park, Ningbo, Zhejiang, China

Tel: +86-20-85543113 (32 lines)

Fax: +86-20-38780406

Complaint line: +86-20-85533471

E-mail: cts@cts-lab.com.cn

See Reverse For Terms And Conditions of Service



PCB view 1.2



PCB view 2.1

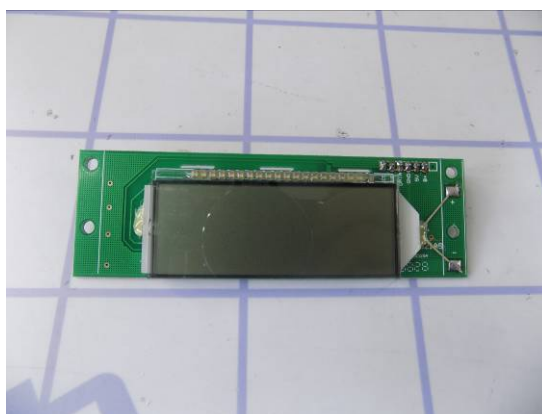

PCB view 2.2

Copyright of this report is owned by Centre of Testing Service and may not be reproduced other than in full except with the written approval of the issuing Company.

CTS (Ningbo) Testing Service Technology Co., Ltd.

2/F., South Tower, Huoju Building, No.181, Canghai Road, Jiangdong Science and Technology Park, Ningbo, Zhejiang, China

Tel: +86-20-85543113 (32 lines)

Fax: +86-20-38780406

Complaint line: +86-20-85533471

E-mail: cts@cts-lab.com.cn

See Reverse For Terms And Conditions of Service



PCB view 3.1

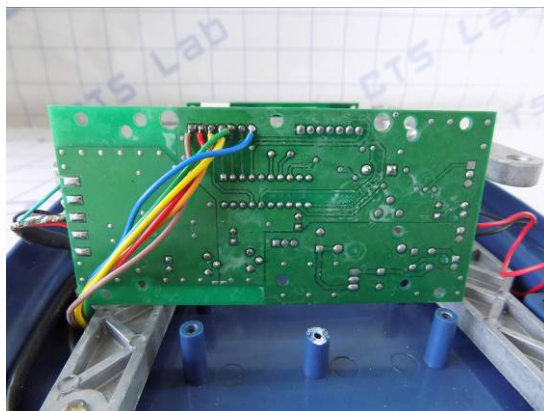

PCB view 3.2

Copyright of this report is owned by Centre of Testing Service and may not be reproduced other than in full except with the written approval of the issuing Company.

CTS (Ningbo) Testing Service Technology Co., Ltd.

2/F., South Tower, Huoju Building, No.181, Canghai Road, Jiangdong Science and Technology Park, Ningbo, Zhejiang, China

Tel: +86-20-85543113 (32 lines)

Fax: +86-20-38780406

Complaint line: +86-20-85533471

E-mail: cts@cts-lab.com.cn

See Reverse For Terms And Conditions of Service

9 Manufacturer/ Approval holder Declaration

The following identical model(s):

SCT,	LCT,	MCT,	MCT PLUS,	HRB,
HRB-E,	LVS,	LC-VS,	MRW,	WPB,
MSS,	PIZA,	CSS,	SCS,	LDS,
LBS,	SC,	KMR,	KHR,	RKS,
TSB,	SSB,	WEIGH BAR,	LWC,	MED-CAN,
HRS-Handrail Scale,		MRB		

Belong to the tested device:

Product description: **ELECTRONIC SCALE**
Model name: **FRH**