

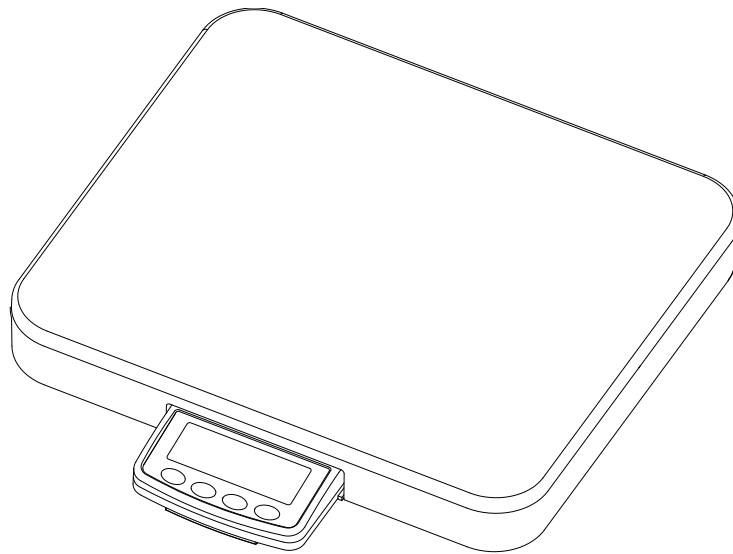

LW MEASUREMENTS, LLC

**Portable Scale  
CSS Series  
Operation Manual**



# Table of Contents

<u>Section</u>	<u>Page</u>
Declaration of Conformity	3
Customer Service	4
Introduction	4
Safety	5
Features	6
Application & Conformity	6
Getting Started	7
Delivery	7
Indicator Description	8
Functions	9-10
Calibration	10
Maintenance & Service	11
Transportation & Storage	11
Warranty	12

# Declaration of Conformity

Declaration of conformity for apparatus with CE mark

We hereby declare that the product to which this declaration refers conforms to the following standards.

Electronic scale: CSS Series

Mark applied	EU Directive	Standards
	2004/108/EC	EN 61326-1: 2006

Signature:



Boon Lim, R & D Manager

Date: 06.27.16

LW Measurements LLC, 620 Carlson Court, Rohnert Park, CA 94928

# Customer Service

## **USA**

LW Measurements LLC,  
620 Carlson Court,  
Rohnert Park, CA 94928  
USA

Tel: (707) 542-2185  
FAX: (707) 542-3285

<http://lwmeasurements.com>

## Introduction

What you should know about these Operating Instructions:

Tree® Professional Weighing Equipment products are simple to operate.

Nevertheless, you should read through these operating instructions in their entirety, so that you can make optimum use of the full potential and the diverse possibilities of the weighing scale in your daily work.

These operating instructions contain guidance in the form of pictograms and keyboard diagrams, which should help you in finding the required information:

For the labeling of potential hazards and advice, please see Safety below

# Safety

## Representations and symbols

Important instructions, which involve safety, are highlighted with the appropriate mark:



## Safety recommendations

When using the weighing equipment in surroundings with increased safety requirements, the corresponding regulations must be observed.

The weighing scale may only be used with the power adapter supplied. Before connecting the power adapter to the scale, the user must ensure that the operating voltage stated on the power adapter is compliant with the mains voltage. If not, please contact Customer Service at the address above.

If the power adapter or its cable is damaged, the weighing scale must immediately be disconnected from the electricity supply (pull out the power adapter).

If there should be any reason to believe that it is no longer safe to operate the scale, it should be immediately unplugged from the electricity supply (pull out power adapter) and secured against inadvertent operation.

In carrying out maintenance work, it is essential to follow the recommendations set out in maintenance and servicing.

The weighing scale must not be operated in an area subject to explosion risks.

Care must be taken when weighing liquids to ensure that no liquid is spilled into the inside of the scale or into connections on the rear of the equipment or the power adapter. If liquid is spilled on the scale, it must immediately be unplugged from the main electricity supply (pull out power adapter).

The weighing scale may be operated after it has first been inspected by a service technician.

These operating instructions must be read by each user and should be easily accessible at the workplace at all times.

## Features

Model number	Capacity	Division
CSS-400	400lb/181Kg	0.1lb/0.05Kg
CSS-200	200lb/90Kg	0.05lb/0.02Kg
Platter / Tray	14 x 16inch/355×405mm	
Net/gross weight	2.8 kg/4.2 kg	
Package	Standard carton:530x450x115 (mm <sup>3</sup> )	
	5 Units in one box: 640x560x485(mm <sup>3</sup> )	
Operating Temperature	Optimum: 15-30°C (62-90f)	
Indicator Power source	4×AA Batteries or AC/DC	
	Adapter 6V /100mA	

- Auto shut off (selectable)
- Auto zero tracking
- Large LCD
- Large square weighing tray.
- Auto calibration
- AC Power
- kg /lb. calibration
- Auto backlight (selectable)

## Application & Conformity

The weighing scale may only be used for the weighing of solid-materials and of liquids filled into secure containers.

The maximum capacity load of the weighing scale must never be exceeded, otherwise the weighing scale may be damaged.

In using the weighing scale in combination with other devices as well as with devices produced by other manufacturers, the appropriate regulations for the safe use of the relevant attachments and their application in accordance with instructions must be observed.

The weighing scale has been manufactured and tested in accordance with the standards and recommendations set out in the declaration of conformity.

The power adapter supplied for the weighing scale complies with the appropriate electrical protection class.

## Getting Started

The scale is packaged in an environmentally-friendly carton, which provides optimum protection for the balance during transportation.

We suggest that you keep the original packaging in order to avoid damage if you are shipping or transporting the scale to a different location. It is also the best way to keep it in the best conditions if it will not be used for an extended period of time.

In order to avoid damage, please follow the instructions provided below, when unpacking the scale:

- Unpack the scale carefully.
- When outside temperatures are very low, the scale should be stored for a couple hours and kept in its box in a dry room at normal temperature, so that no condensation settles on the unit when opening the box.
- Check the scale immediately after unpacking for any external visual damage. If there is any damage on scale, contact customer service immediately.
- If the scale is not to be used immediately after purchase, it should be stored in a dry place where fluctuations in temperature are low. (Reference pg.11)
- Read through these operating instruction, before you work with the unit and pay attention to the Safety recommendations. (Reference pg. 5)

## Delivery

Inspect delivery for completeness immediately on unpacking all components.

### **Checklist for complete delivery**

	<b>Component delivered present yes / no</b>
Weighing unit body	
Weighing pan	
Power adapter	
Operating manual	

# INDICATOR DESCRIPTION

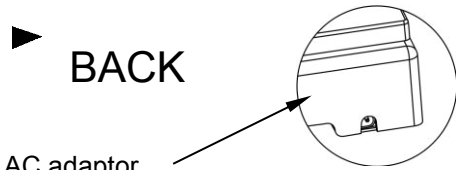

**BACK**

AC adaptor  
Socket

**ON/OFF key**  
Turns the scale  
Power on/off.

**UNIT key**  
Change weighing units, e.g. Kg or lb.

**TARE key**  
Tare Range (100% to full capacity)

**ZERO key**  
Set display to zero or  
Zero Range (4% to full capacity)

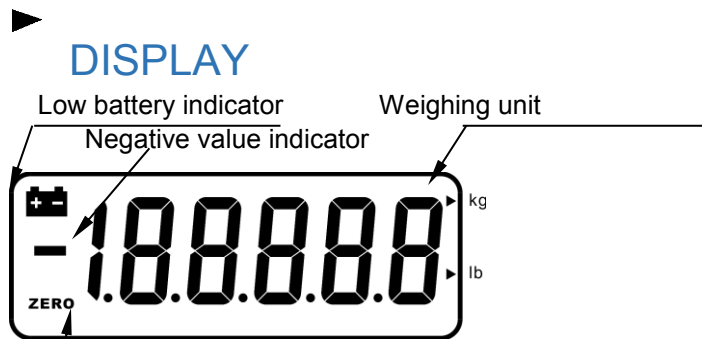
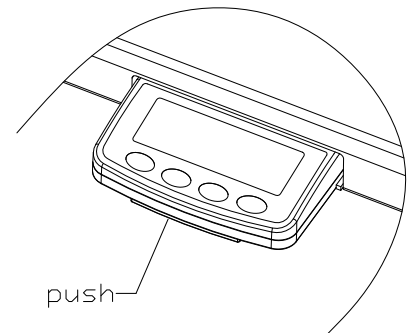
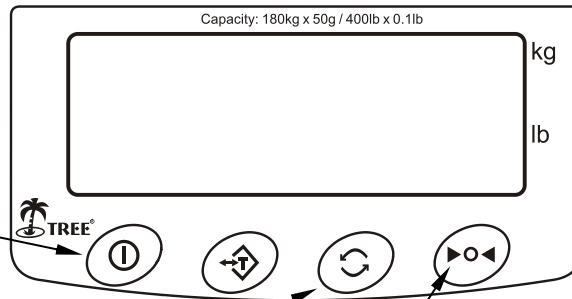

**ZERO indicator**  
Indicates when the reading is 0

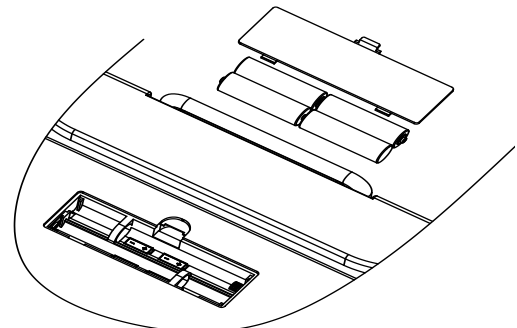



# Functions

## **Before weighing**

Whenever possible, please allow the scale to warm up for several seconds after first turning the power on so that the scale will function properly and accurately.

Error messages

: Low battery

Err-0: Overload

Err-Z : Exceed zero track range when turning on the power

Err- S: The scale is unstable when turning on the power

Err- C: Forgot to input calibration weight when calibrating or the AD value is too low.

## **Weighing procedures**

1. Press [ON/OFF] to turn on the scale.

When the power is turned on, all display segments appear for a few seconds and "0" will appear on the display.

2. Select the weighing unit with [UNIT].

Press [UNIT] to select a weighing unit "kg", or "lb."

Once the unit has been selected, the selected unit will be displayed next to the weight value.

3. Start weighing

### **If you do not use a container for weighing**

Verify the reading is "0". If not, press [ZERO] to display "0".

Place the items to be weighed on the platform.

### **If you use a container for weighing**

Place an empty container on the platform.

Wait for the stability weighing to be displayed and press [TARE].

Place the objects to be weighed in the container.

## FUNCTION SETTINGS

1. Enter function setting mode. Press **[ON/OFF]** to turn the power off, Press **[ZERO]** first, then press **[ON/OFF]**, while keeping **[ZERO]** pressed, the display will show **A\_OFF**.
2. Selection of auto shut off mode. When the scale enters function setting menu, the display will show **A\_OFF**. Press **[ZERO]** to choose ON or OFF: selection display **ON**, this means auto shut off function active. Press **[ZERO]** again, the display will show **OFF**, this means auto shut off function inactive.
3. Selection of auto backlight mode. When the scale enters function setting menu, press **[UNIT]** key, the display will show **L-ON or OFF**. Press **[ZERO]** to choose ON or OFF: selection display **ON**, this means auto backlight function active, press **[ZERO]** again, the display will show **OFF**, this means auto backlight function inactive, i.e. shut off backlight function.
  4. Return to weighing mode. Press **[ON/OFF]** to turn the power off, press **[ON/OFF]** again to turn on the power and the scale will return to the weighing mode.

## Calibration

When to calibrate

If the scale is inaccurate, calibration may be required when the scale is first set up for use, or if the scale is moved to a different altitude. This is necessary because the weight of a mass in one location is not necessarily the same in another location. Also, with time and use, mechanical deviations can occur.

**Note: calibration value must be more than 2/3 of the capacity value that you have set.**

1. Press and hold **[UNIT]** key then press ON/OFF key to turn on the scale, the display will show CALU=.
2. Press **[UNIT]** key to select setting unit between kg and lb. , Press **[TARE]** key, the display will show XXX.XX kg(or lb.)
3. Press **[UNIT]** key to move flash digit to right, press **[ZERO]** key to increase flash digit... Press **[TARE]** key; the display will show -CAL-, Press **[UNIT]** key, the

display will show AD value. Press 【UNIT】 key, the display will show flashed calibration weight. Place the shown weight then press 【UNIT】 key, the display will show ----- then AD value. Take off calibration weight then turn off the scale. Calibration is finished. If calibration is repeatedly incorrect then: 1) Replace the batteries, 2) Try a more stable surface or a vibration and interference free location.

## Maintenance and service

The weighing machine must be treated carefully and cleaned regularly. It is a precision instrument.



For maintenance-work, the balance must be disconnected from the power supply (remove power adapter plug from socket). Also ensure that the balance cannot be connected to the power supply during the work by a third party.

Make sure that no liquid spills into the scale while performing maintenance work. If liquid is spilled on the scale, it must be inspected by a service technician.

Regularly perform maintenance to the weighing pan and the weighing pan holder by

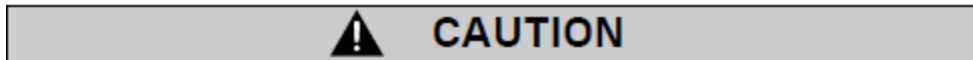

removing any dirt or dust from under

the weighing pan and on the weighing scale housing. Use a soft brush or a soft, lint-free cloth, moistened with a mild soap solution.

Never use solvents, acids, alkalis, paint thinners, scouring powders or other aggressive or corrosive chemicals for cleaning; these substances can cause damage to the scale.

## Transport & Storage

Your weighing machine is a precision instrument, treat it carefully. Avoid shaking, severe impacts and vibration during the transportation. Make sure that there are no marked temperature fluctuations during the transportation and that the weighing machine does not become damp (condensation).

If you would like to take the weighing machine out of service for an extended period, disconnect it from the electricity supply, clean it thoroughly (refer to Maintenance & Service) and store it in a place which meets the following conditions:

- No violent shaking, no vibrations
- Minimum temperature fluctuations
- No direct solar radiation
- Minimum moisture

## Warranty

The products are under warranty against factory defects for a period of two (2) years from the date of shipment.

For Customers within the lower 48 states of the continental United States. LW Measurements will pay for freight both ways for the first 30 days after purchase. After 30 days expire the customer is responsible for shipping the product back to us. After the product is received we will inspect it and as necessary we will repair or replace and will ship the product back to the customer at our expense.

Any new scales returned for warranty must be properly packaged in the original box. If they are not properly packed in the original box, the customer pays for shipping cost. If we determine there is a factory defect, we will pay for the shipping back. If we determine that it is not a factory defect, the customer will pay shipping.

For Customers outside the lower 48 States, including Mexico, Canada, Puerto Rico, Hawaii, Alaska and all other countries, customers must pay for shipping.

Our warranty does not cover misuse or neglect including but not limited to battery or water damage, overloading, and chewed or cut wires. If the product is found to have been misused or damaged by the customer, LW measurements is not responsible for the cost of return.

For warranty claims please go online to [lwmeasurements.com](http://lwmeasurements.com) and fill out the warranty submission form or call your customer service representative.